

SPECIFIKACIJA



MINI BAGER | 25z-1 / 26c-1

Radna težina: 2526 – 2651 kg Ukupna snaga motora: 18,4 kW Sila kidanja žlice: 22,3 – 25,9 kN



GOTOVO NEPOBJEDIV.

Predstavljamo novu generaciju 25z-1 i 26c-1 JCB mini bagera: dizajniran imajući na umu izdržljivost, pouzdanost i vuču.

GOTOVO NEPOBJEDIV U UDOBNOСТИ.

Iskusite neprikosnovenu udobnost naše redizajnirane kabine. Klima-uređaj po želji, prostrana ravni prostor, vrhunsko sjedalo s pneumatskom amortizacijom i Bluetooth radio čine ga idealnim radnim mjestom.



GOTOVO NEPOBJEDIV U IZVEDBI.

Napravili smo impresivna poboljšanja u hidraulici, na gusjenicama i dodacima – a pogoni ga potpuno novi Kohler motor od 18,4 kW.



GOTOVO NEPOBJEDIV U IZDRŽLJIVOSTI.

U svijetu surovih okruženja, JCB mini bageri su nepobjedivi. Napravljeni da izdrže izazove na svim lokacijama, bageri osiguravaju pouzdanost kada je najvažnije.



GOTOVO NEPOBJEDIV U SIGURNOSTI.

Follow-me-home radna svjetla i naš jedinstveni 2GO sustav hidraulične izolacije pružaju dodatnu sigurnost na gradilištu, a istovremeno održavaju sigurnu vučnu težinu za dodatnu mobilnost.



GOTOVO NEPOBJEDIV U TROŠKU VLASNIŠTVA.

JCB mini bageri dizajnirani su za niže operativne troškove s 500-satnim intervalima podmazivanja, funkcijama automatskog zaustavljanja i mirovanja, obojenim hidrauličkim crijevima, plus ravnim staklom.

STATIČKE DIMENZIJE

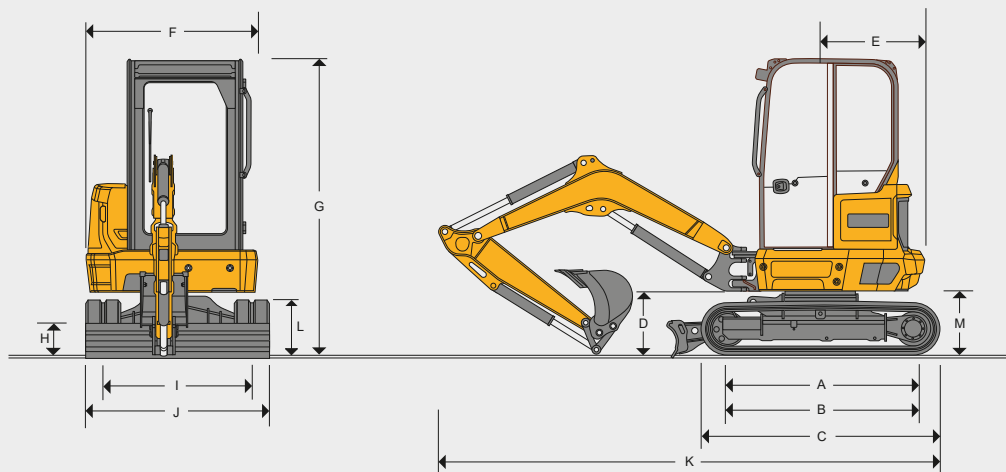

Model stroja		25z-1	26c-1
A	Centri zupčanika	mm	1562
B	Dužina gusjenica na tlu	mm	1562
C	Ukupna dužina podvozja – guma	mm	1988
D	Razmak rukava osovine	mm	510
E	Polumjer zanošenja Standardno / HD protuteža	mm	775 / 880 1005 / 1110
F	Ukupna širina nadgradnje	mm	1445
G	Visina preko kabine	mm	2478
	Visina iznad krova	mm	2474
H	Visina podvozja	mm	264
I	Razmak između gusjenica	mm	1250
J	Širina preko gusjenica – 250 mm gusjenice	mm	1500
	Širina preko gusjenica – 300 mm gusjenice	mm	1550
K	Transportna dužina	mm	4200 4350
L	Visina gusjenica	mm	450
M	Visina protuutega	mm	525

MOTOR

Model stroja		25z-1, 26c-1
Model		Kohler KSD1403 NA
Gorivo		Dizel
Hlađenje		Hlađeno vodom
Ukupna snaga ISO 14396	kW	18,4 @ 2200 o/min
Neto snaga	kW	16,7 @ 1900 o/min
Ukupni okretni moment ISO 14396	Nm	45,6 @ 2000 o/min
Zapremina	cc	1391
Rad na nagibu	stupnjevi	35
Motor za pokretanje	kW	2,2
Akumulator	volt / ampera	12 / 80
Alternator	ampera (klima-uređaj)	80

PODVOZJE

Model stroja		25z-1	26c-1
Broj gornjih valjaka (po strani)			1
Broj donjih valjaka (po strani)			3
Širina gusjenice guma	mm		250 / 300
Širina gusjenice čelik	mm		N/A
Pritisak stroja na tlo guma 250 mm	kg/cm ²	0,32	0,34
Pritisak stroja na tlo guma 300 mm	kg/cm ²	0,31	0,33
Napetost gusjenice		Podmazivanje	
Brzina kretanja – niska	km/h		2,2
Brzina kretanja – visoka	km/h		4,4
Prianjanje	kN		22

HIDRAULIČNI SUSTAV

Model stroja		25z-1	26c-1
Pumpa	cc		38
Nazivna izlazna snaga @ 2000 o/min	l/min		76
Glavno rasterećenje tlaka bagera/gusjenice	bar		250
Okretno glavno rasterećenje tlaka	bar		176
Pomoćni hidraulični pritisak (Aux1)	bar		STD: 190 ADJ: 120 – 250
Pomoćni hidraulični pritisak (Aux2)	bar		STD: 190 ADJ: 120 – 250
Pomoćni hidraulični protok (Aux1)	l/min		48
Pomoćni hidraulični protok (Aux2)	l/min		25
Hidraulička pumpa		Klip varijabilne zapremnine	

TEŽINE

Model stroja		25z-1	26c-1
Radna težina stroja (MOW)	kg	2526	2651
Operator	kg	75	75
Masa pri isporuci	kg	2434	2559
Krov	kg	-55	-55
300 mm gumene gusjenice	kg	Montirano	
250 mm gumene gusjenice	kg	-50	
Kopač 1100 mm	kg	Montirano	-9,1
Kopač 1300 mm	kg	+6,5	Montirano
HD kontra težina	kg		+120
Klima-uređaj	kg		+25
FOPS štitnici	kg		+12,6
Hidraulično brzo spajanje	kg		+35,6
Dozer HBVC	kg		+1,5
Grana i kopač HBVC	kg		+7,5
Zaštita okvira žlice	kg		+3,3
Zaštita okvira kopača	kg		+4,4

Težina operatora prema ISO 6016 uključujući kabinu, gumene gusjenice, žlicu od 400 mm, pune spremnike i operatora od 75 kg. Otpremna težina prema ISO 6016 je masa osnovnog stroja bez operatora, s razinom goriva na 10 % kapaciteta spremnika.

SERVISNE KOLIČINE

Model stroja	25z-1	26c-1
Spremnik goriva	l	30
Rashladno sredstvo motora	l	5,1
Motorno ulje	l	3
Hidraulični sustav	l	45
Hidraulički spremnik	l	20

OPERATER OKOLIŠA

Model stroja	25z-1	26c-1
Visina kabine/krova	mm	1591
Visina kabine/krova sa zaštitom FOGS RAZINE 1	mm	1610
Duljina kabine/krova sa zaštitom FOGS RAZINE 1	mm	1268
Dužina kabine/krova	mm	1251
Širina kabine/krova	mm	973
Širina otvorenih vrata	mm	428

DOZER

Model stroja	25z-1	26c-1
Dužina dozera (STD – (Središte od vrha do dna))	mm	790
Maksimalna visina iznad tla	mm	301
Dubina kopanja ispod zemlje	mm	299
Kut pristupa	stupnjevi	34
Širina	mm	1550
Visina	mm	310

RADNI OPSEG

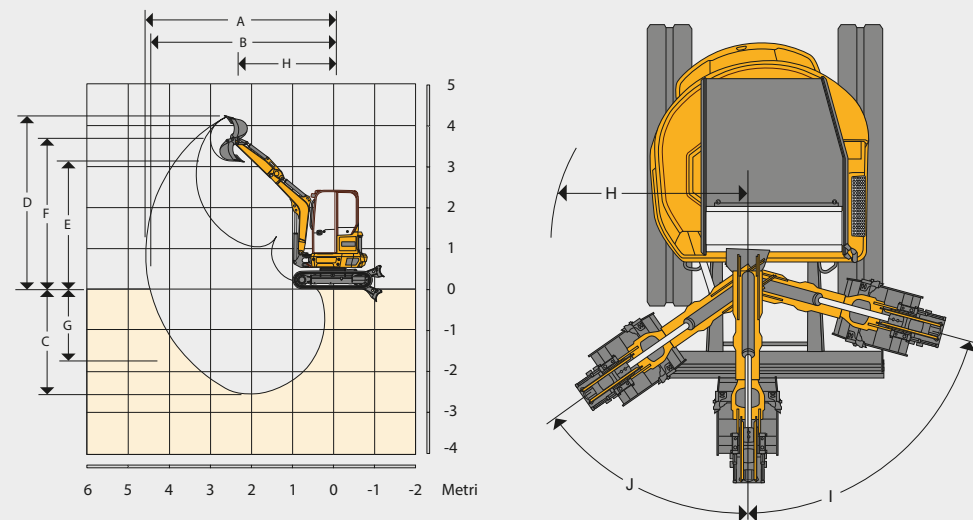

		25z-1		26c-1	
Duljina kopača	mm	1100	1300	1100	1300
Duljina grane	mm	2090		2370	
A Maksimalni doseg kopanja	mm	4465	4656	4511	4702
B Maksimalni doseg kopanja na tlu	mm	4356	4553	4410	4605
C Maksimalna dubina kopanja – dozer gore	mm	2437	2637	2661	2860
Maksimalna dubina kopanja – dozer dolje	mm	2624	2824	2838	3037
D Maksimalna visina zamaha kopanja	mm	4141	4277	4223	4344
E Maksimalna visina istovara/utovara	mm	3030	3166	3124	3246
F Maksimalna visina do zakretnog klina vrha kopača	mm	3589	3725	3684	3805
G Maksimalna vertikalna dubina zidnog reza	mm	1456	1629	1582	1754
H Minimalni polumjer prednjeg zaokreta (bez pomaka)	mm	2025	2076	1907	1929
Minimalni polumjer prednjeg zaokreta (puni pomak)	mm	1584	1627	1553	1573
I Zamah grane lijevo	stupnjevi	75			
J Zamah grane desno	stupnjevi	55			
Rotacija žlice	stupnjevi	192		193	
Rotacija kopača	stupnjevi	118		123	
Sila kidanja žlice	kN	22,3		25,9	
Sila kidanja kopača	kN	16,3	14,5	18,7	16,7
Slaba brzina	o/min	9,7			





















OPREMA

	25z-1	26c-1		25z-1	26c-1
Potpuno ostakljena ROPS & TOPS certificirana kabina	•	•	1300 mm kopač	+	•
Povremeni brisač s pranjem/brisanjem koji se može programirati	•	•	1100 mm kopač	•	+
Grijač/odmagljivač s 3 stupnja i prilagodljivim ventilatorima zraka	•	•	Klimatizacijski uređaj	+	+
LCD zaslon	•	•	FOPS faza zaštite 1	+	+
Digitalni sat	•	•	Komplet za podizanje nepovratnog ventila pri pucanju crijeva (dozer, grana i kopač)	+	+
Vanjska kutija za alat sa zaključavanjem	•	•	Mehanička brza spojnica	+	+
Držač čaše i boce	•	•	Hidraulična brza spojnica, spremni cjevovod za hidrauličku brzu spojnicu	+	+
Kuka za odjeću, Bluetooth radio	•	•	Žlice za kopanje za opće namjene	+	+
12V i 2 x USB	•	•	Žlice za jarke/terase	+	+
Unutarnje svjetlo	•	•	Hidraulični čekići	+	+
Sustavi za sve zvučne i vizualne alarme	•	•	LED rotirajuće crveno svjetlo	+	+
Automatski gas u praznom hodu	•	•	Alarm za kretanje / bijeli šum	+	+
8 opsega snage	•	•	Zeleno svjetlo ako je pričvršćen sigurnosni pojas	+	+
ISO servo komande s elektrohidrauličnom polugom dozera	•	•	Hidraulički priključak za palac	+	+
Elektroproporcionalni pomoćni uređaj s dvostrukim djelovanjem visokog protoka kontroliran palcem	•	•	Vanjska ogledala na kabini	+	+
10 programa pomoćnih protoka	•	•	JCB imobilizator (jedinstvena tipka ili tipkovnica)	+	+
Prekidač čekića montiran na upravljačku palicu	•	•	Plovak dozera	+	+
Pokretanje u neutralnom položaju, potpuna izolacija upravljanje	•	•	Kontrole dvostrukog obrasca (prebacivanje ISO/SAE)	+	+
„2GO“ hidraulična izolacija	•	•	Opcije posebnih boja	+	+
Vrhunsko sjedalo s pneumatskom amortizacijom	•	•	Certificirani ROPS & TOPS krov	+	+
Podna prostirka koja se može ukloniti	•	•	Nagib rotacija spremna instalacija	+	+
Kompleta za spremno rotirajuće svjetlo	•	•	JCB Livelink	+	+
Gusjenice s dvije brzine	•	•	Narančasti sigurnosni pojas	+	+
Automatsko smanjenje stupnja prijenosa motora gusjenica	•	•	Radio	+	+
Gumene gusjenice kratkog koraka 300 mm	•	•	Dugi dozer	+	+
Alternator za teške uvjete rada	•	•	Kutija za dokumente	+	+
Akumulator za teške uvjete rada	•	•	Širokokutni retrovizor	+	+
Hidrauličko okretno kočenje s parkirnom kočnicom s diskom	•	•	Protuteža od 120 kg pričvršćena vijcima	+	+
ORFS hidraulika	•	•			
Hidraulične cijevi označene bojama	•	•			
Intervali podmazivanja na kraju kopanja i dozera od 500 sati	•	•			
Zaštita cilindra grane za teške uvjete rada	•	•			
Zaštićena radna svjetla grane	•	•			
Pomoćne spojnice za brzo otpuštanje	•	•			
100 % čelična karoserija	•	•			
Namjenske točke za vezivanje i podizanje	•	•			
CESAR oznaka podataka (samo u UK).	•	•			
Pištalj i kartuša za podmazivanje	•	•			
500-satno podmazivanje – čahure natopljene grafitom	•	•			
Rukavac osovine za teške uvjete rada	•	•			
Kopač spreman za upravljanje palcem	•	•			
Radio spreman – zvučnici i antena	•	•			
Izolator akumulatora	•	•			

STANDARD • OPCIONALNO +





















KAPACITETI PODIZANJA – KABINA, 1100 MM KOPAČ, STANDARDNA PROTUTEŽA, 250 MM GUSJENICE

25Z-1

Točka utovara	1,0			1,5			2,0			2,5			3,0			3,5			3,9		
																					
Visina	Dozer gore	Dozer dolje	Preko strane	Dozer gore	Dozer dolje	Preko strane	Dozer gore	Dozer dolje	Preko strane	Dozer gore	Dozer dolje	Preko strane	Dozer gore	Dozer dolje	Preko strane	Dozer gore	Dozer dolje	Preko strane	Dozer gore	Dozer dolje	Preko strane
m	kg	kg	kg	kg	kg	kg	kg	kg	kg	kg	kg	kg	kg	kg	kg	kg	kg	kg	kg	kg	kg
2,5													463	602	394						
2,0										616	703	520	455	645	386	351	617	298			
1,5										589	861	494	440	722	372	344	648	291			
1,0										560	1029	467	425	808	358	336	690	283	283	579	239
0,5										538	1146	447	412	877	345	328	723	276			
0,0							750	1672	608	527	1186	436	404	908	337	324	732	272			
-0,5	1260	1260	1260	1304	1486	1012	752	1570	610	525	1152	434	401	887	335	324	691	272			
-1,0	1852	1852	1852	1317	1975	1023	761	1387	618	530	1039	438	405	790	339						
-1,5				1343	1484	1046	778	1078	634	543	798	451									
-2,0																					

KAPACITETI PODIZANJA – KABINA, 1300 MM KOPAČ, STANDARDNA PROTUTEŽA, 250 MM GUSJENICE

25Z-1

Točka utovara	1,0			1,5			2,0			2,5			3,0			3,5			4,0			4,1		
																								
Visina	Dozer gore	Dozer dolje	Preko strane	Dozer gore	Dozer dolje	Preko strane	Dozer gore	Dozer dolje	Preko strane	Dozer gore	Dozer dolje	Preko strane	Dozer gore	Dozer dolje	Preko strane	Dozer gore	Dozer dolje	Preko strane	Dozer gore	Dozer dolje	Preko strane			
m	kg	kg	kg	kg	kg	kg	kg	kg	kg	kg	kg	kg	kg	kg	kg	kg	kg	kg	kg	kg	kg			
2,5													472	541	402	360	560	307						
2,0													462	590	393	357	572	304						
1,5							873	1006	721	601	782	506	448	674	379	349	613	296	279	575	236			
1,0										571	964	477	431	769	364	340	663	287	275	598	232			
0,5										546	1108	454	416	851	349	331	707	279	271	612	228			
0,0							753	1697	611	531	1179	440	406	900	340	325	732	273						
-0,5	1089	1089	1089	1291	1349	1000	751	1637	609	525	1176	434	401	902	335	322	719	270						
-1,0	1571	1571	1571	1304	1962	1012	756	1491	614	527	1097	436	402	842	336	326	626	274						
-1,5	2154	2154	2154	1327	1793	1032	770	1237	626	536	918	445	412	661	345									
-2,0							773	773	651															



Kapacitet podizanja, preko prednje strane.























Kapacitet podizanja, puni krug

Napomene:

- Kapaciteti podizanja temelje se na standardu ISO 10567 koji iznosi: 75 % minimalnog opterećenja prevrtanja ili 87 % hidrauličkog kapaciteta dizanja, što god je manje.
- Kapaciteti podizanja označeni znakom * temelje se na hidrauličkom kapacitetu.
- Kapaciteti podizanja pretpostavljaju da je stroj na čvrstom ravnom tlu i opremljen odobrenom točkom dizanja.
- Prilikom podizanja mora biti postavljena žlica, težina te žlice mora se oduzeti od gore navedenih nosivosti dizanja.
- Kapaciteti podizanja mogu biti ograničeni lokalnim regulativama. Obratite se svom distributeru.
- Dodatna protuteža od 120 kg pričvršćena vijcima ponudit će veću stabilnost.

















KAPACITETI PODIZANJA – KABINA, 1100 MM KOPAČ, STANDARDNA PROTUTEŽA, 250 MM GUSJENICE

26C-1

Točka utovara	1,0			1,5			2,0			2,5			3,0			3,5			3,9		
																					
Visina	Dozer gore	Dozer dolje	Preko strane	Dozer gore	Dozer dolje	Preko strane	Dozer gore	Dozer dolje	Preko strane	Dozer gore	Dozer dolje	Preko strane	Dozer gore	Dozer dolje	Preko strane	Dozer gore	Dozer dolje	Preko strane	Dozer gore	Dozer dolje	Preko strane
m	kg	kg	kg	kg	kg	kg	kg	kg	kg	kg	kg	kg	kg	kg	kg	kg	kg	kg	kg	kg	kg
2,5													601	646	530	462	641	408			
2,0										783	783	690	588	697	518	458	650	404			
1,5							1074	1258	919	756	926	658	571	769	501	449	682	396			
1,0										724	1060	628	553	843	484	439	719	386	373	653	328
0,5										701	1144	606	538	897	470	431	747	378	368	658	323
0,0				1464	1464	1382	978	1555	829	689	1165	595	529	917	461	425	752	372			
-0,5	1840	1840	1840	1706	1735	1392	980	1467	831	686	1129	592	525	895	457	424	718	371			
-1,0				1433	1433	1414	989	1326	840	690	1036	596	529	818	461						
-1,5							1006	1107	855	703	864	608									
-2,0							732	732	732												

KAPACITETI PODIZANJA – KABINA, 1300 MM KOPAČ, STANDARDNA PROTUTEŽA, 250 MM GUSJENICE

26C-1

Točka utovara	1,0			1,5			2,0			2,5			3,0			3,5			4,0			4,1		
																								
Visina	Dozer gore	Dozer dolje	Preko strane	Dozer gore	Dozer dolje	Preko strane	Dozer gore	Dozer dolje	Preko strane	Dozer gore	Dozer dolje	Preko strane	Dozer gore	Dozer dolje	Preko strane	Dozer gore	Dozer dolje	Preko strane	Dozer gore	Dozer dolje	Preko strane			
m	kg	kg	kg	kg	kg	kg	kg	kg	kg	kg	kg	kg	kg	kg	kg	kg	kg	kg	kg	kg	kg			
2,5													594	594	540	471	590	417						
2,0										714	714	703	597	650	527	465	612	411						
1,5							1103	1129	947	770	862	672	579	729	509	455	652	402	367	607	324			
1,0							1035	1420	883	735	1010	639	560	811	490	444	697	391	362	624	319			
0,5							995	1569	846	709	1117	614	543	878	474	434	734	381	357	636	313			
0,0							980	1585	832	693	1164	599	531	913	463	427	752	374	353	629	310			
-0,5	1057	1057	1057	1383	1383	1366	978	1526	830	687	1151	593	526	909	458	423	739	370						
-1,0	1593	1593	1593	1690	1926	1378	984	1408	835	688	1083	594	526	857	458	426	672	373						
-1,5	2207	2207	2207	1640	1640	1399	997	1220	847	697	947	602	535	730	466									
-2,0				1209	1209	1209	918	918	870	681	681	622												



Kapacitet podizanja, preko prednje strane.



Kapacitet podizanja, puni krug

Napomene:

- Kapaciteti podizanja temelje se na standardu ISO 10567 koji iznosi: 75 % minimalnog opterećenja prevrtanja ili 87 % hidrauličkog kapaciteta dizanja, što god je manje.
- Kapaciteti podizanja označeni znakom * temelje se na hidrauličkom kapacitetu.
- Kapaciteti podizanja pretpostavljaju da je stroj na čvrstom ravnom tlu i opremljen odobrenom točkom dizanja.
- Prilikom podizanja mora biti postavljena žlica, težina te žlice mora se oduzeti od gore navedenih nosivosti dizanja.
- Kapaciteti podizanja mogu biti ograničeni lokalnim regulativama. Obratite se svom distributeru.
- Dodatna protuteža od 120 kg pričvršćena vijcima ponudit će veću stabilnost.



JEDNA TVRTKA, VIŠE OD 300 STROJEVA.

Distributer tvrtke JCB u blizini

Mini bager 25z-1 / 26c-1

Radna težina: 2526 – 2651 kg Ukupna snaga motora: 18,4 kW Sila kidanja žlice: 22,3 – 25,9 kN

JCB Sales Limited, Rocester, Staffordshire, United Kingdom ST14 5JP.

Tel.: +44 (0)1889 590312 E-pošta: salesinfo@jcb.com

Preuzmite najnovije informacije o ovom asortimanu proizvoda na: www.jcb.com

©2024 JCB Sales. Sva prava pridržana. Nijedan dio ove publikacije ne smije se reproducirati, pohranjivati u sustavu za ponovno dohvaćanje ili prenositi ni u kojem obliku ili bilo kojim sredstvima, elektroničkim, mehaničkim, fotokopirnim ili drugim, bez prethodnog dopuštenja tvrtke JCB Sales. Sve reference u ovoj publikaciji u vezi s radnim težinama, veličinama, zapreminama i drugim mjerama izvedbe informativne su prirode i mogu se razlikovati ovisno o točnoj specifikaciji stroja. Stoga se na njih ne treba oslanjati u vezi s prikladnošću za konkretnu primjenu. Smjernice i savjete uvijek treba zatražiti od prodavatelja tvrtke JCB. JCB pridržava pravo promjene specifikacija bez prethodne najave. Prikazane ilustracije i specifikacije mogu uključivati opcije opreme i dodatka. Logotip tvrtke JCB registrirani je zaštitni znak tvrtke J.C. Bamford Excavators Ltd.

31448 hr-HR 01/24 izdanje 1

